

# Data Sheet



Article number: 03510150

Description: Fluro Rod end GE 150SW

## Measures

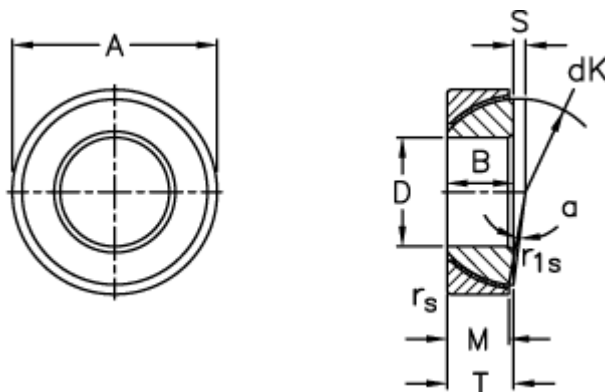

A = 225 0 -0,030

B = 48

D = 150 0 -0,025

dK = 211

Dynamic load C (kN) = 1530

M = 46

rs, r1s min = 3

S = 20

Static load C0 (kN) = 3060

T = 48 +0,35 -0,70

Tilt angle = 1

Weight = 8010